

PARTS LIST

80cm Boats



 Manufactured in the United Kingdom



Contents;

- 2 - Boat console - Page 1
- 3 - Boat console - Page 2
- 4 - Boat steering wheel assembly
- 5 - Boat forward/reverse stick assembly
- 6 - Multi mech coin door
- 7 - Boat TX & TX motherboard
- 8 - Boat console motherboard
- 9 - Boat power supply/receiver
- 10 - Boat charger & battery
- 11 - Boat hull less motors
- 12 - Boat Hull complete
- 13 - Boat top fixing guide
- 14 - Boat tops
- 15 - Spares pack

www.tornado-uk.com
sales@tornado-uk.com
Tel +44 121 773 1827

Tornado International Limited
Unit 20
Stirchley Trading Estate
Hazelwell Road
Stirchley
Birmingham
B30 2PF
England, United Kingdom

- 1 - This parts list is for a boat set operating on a loop aerial system at a frequency of 137KHz. Your set may use a different system or frequency. Please contact Tornado quoting your serial number if you are unsure when reordering parts.

Item	Part Number	Description
1	6J00-885	Console mother PCB assembly 99
2	6J00-200/201	Genesis boat steering wheel assembly
3a	2G01-810	99 Console moulding white drilled
3b	3G01-810	99 Console drilled with 1x access door (master console only)
4	2J00-201	Cash box assembly 2003
5	2J00-801	Cash box locating block
6	1H00-725	Cash box strap (hasp)
7	0F05-016	Pop rivet aluminium domed open 3.2x11.5mm black
8	1H00-351	Spacer nylon tapped M5 6.35x9.53mm
9	0F00-506	Nut M5 thumb nylon knurled
10	0F00-586	M screw M5x30MM socket button head stainless steel
11	0F05-015	Pop rivet aluminium domed open 3.2x11.5mm
12	0F05-056	Pop rivet aluminium domed open 4x13.9mm
13	1L01-003	Genesis credit label 2007
14	1H08-052	PVC clear 120x103x3mm
15	0F07-353	Cable 'P' clip 12.5mm white
16	0F05-931	Hex self drill 4.8x19(10x3/4) stainless steel
17	2J07-005	Sports cruiser steering wheel Loom
18	3J01-850	2007 Multi mech coin door assembly*
19	0F05-956	Cup hook screwed
20	0F00-588	M screw M5 x 30mm socket countersunk stainless steel
21	0F07-284	Clamp for 16 way ribbon cable with sticky back
22	0H00-740	Spacer nylon tapped M5 12.7mm x 9.35mm
23	0F00-610	Washer M6x25MM stainless steel PSS6 1/4x1"
24	0F00-510	Washer M5x25MM stainless steel (2BAX1")
25	0F00-607	Nut M6 wing stainless steel
26	3J00-806	Console access door white with lock (Master console only)

8J07-810 - Genesis master console

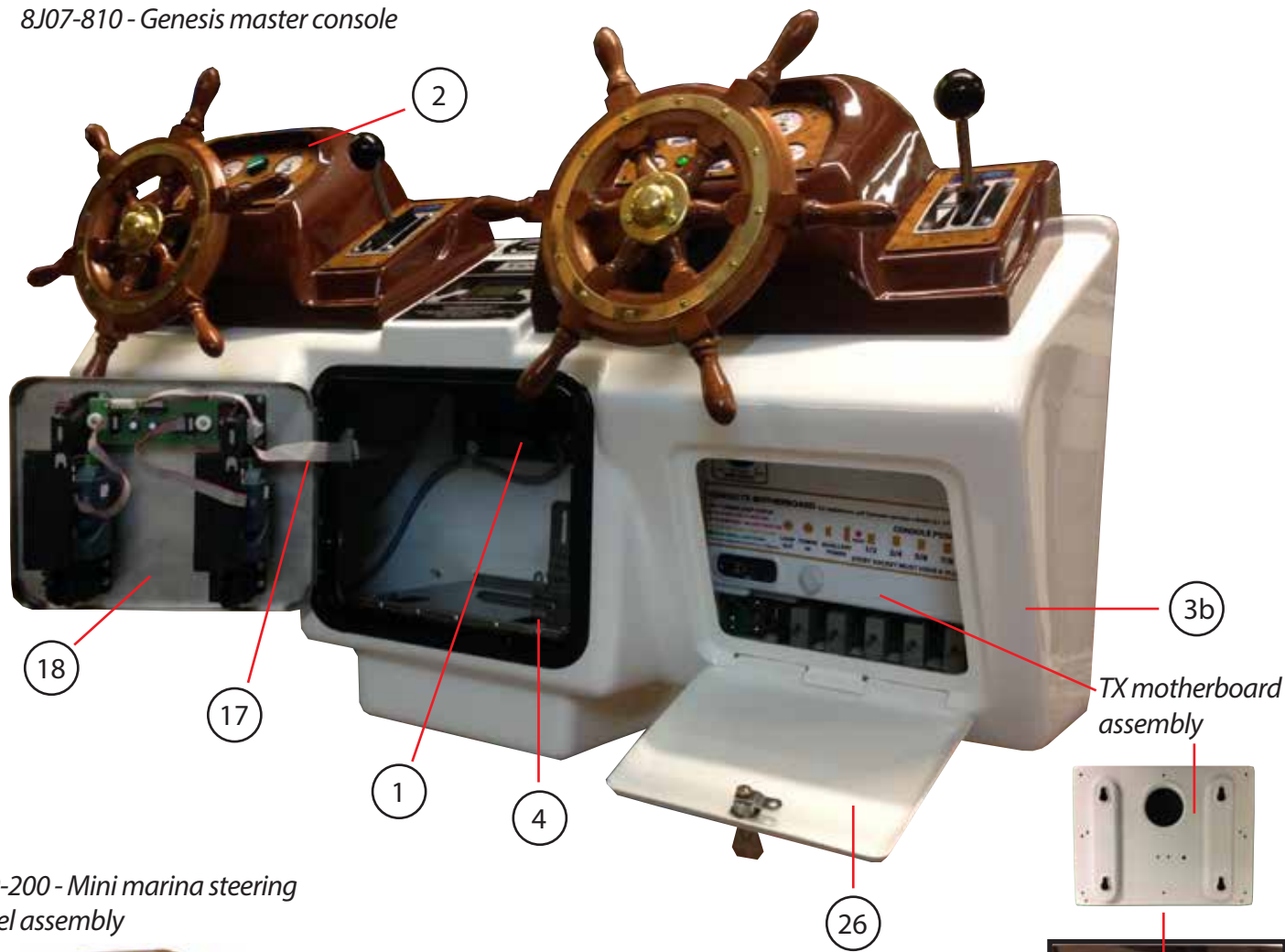

(Not all items are on this page, some are on the next page)

8J07-809 - Genesis standard console



6J00-200 - Mini marina steering wheel assembly



6J00-201 - Pirate steering wheel assembly



TX motherboard mountings are at the back of the console.

* Blank doors & note acceptor doors are also available
Themes can be mixed upon request

Note: The information contained in this publication is correct at the time of printing, but owing to the continued development of the products, changes in the specification may be inevitable. The manufacturer reserves the right to implement such changes without prior notice.



Item	Part Number	Description
1	6J00-885	Console mother PCB assembly 99
2	6J00-200/201	Genesis boat steering wheel assembly
3a	2G01-810	99 Console moulding white drilled
3b	3G01-810	99 Console drilled with 1x access door (master console only)
4	2J00-201	Cash box assembly 2003
5	2J00-801	Cash box locating block
6	1H00-725	Cash box strap (hasp)
7	0F05-016	Pop rivet aluminium domed open 3.2x11.5mm black
8	1H00-351	Spacer nylon tapped M5 6.35x9.53mm
9	0F00-506	Nut M5 thumb nylon knurled
10	0F00-586	M screw M5x30MM socket button head stainless steel
11	0F05-015	Pop rivet aluminium domed open 3.2x11.5mm
12	0F05-056	Pop rivet aluminium domed open 4x13.9mm
13	1L01-003	Genesis credit label 2007
14	1H08-052	PVC clear 120x103x3mm
15	0F07-353	Cable 'P' clip 12.5mm white
16	0F05-931	Hex self drill 4.8x19(10x3/4) stainless steel
17	2J07-005	Sports cruiser steering wheel Loom
18	3J01-850	2007 Multi mech coin door assembly
19	0F05-956	Cup hook screwed
20	0F00-588	M screw M5 x 30mm socket countersunk stainless steel
21	0F07-284	Clamp for 16 way ribbon cable with sticky back
22	0H00-740	Spacer nylon tapped M5 12.7mm x 9.35mm
23	0F00-610	Washer M6x25MM stainless steel PSS6 1/4x1"
24	0F00-510	Washer M5x25MM stainless steel (2BAX1")
25	0F00-607	Nut M6 wing stainless steel
26	3J00-806	Console access door white with lock (Master console only)

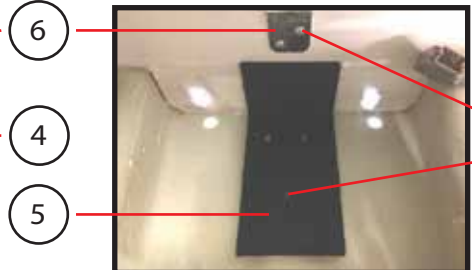
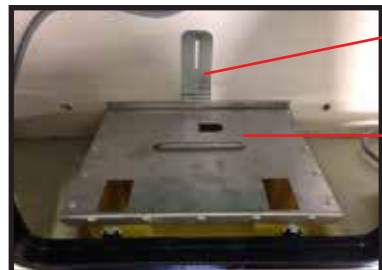

Position labels;
 1L08-010 - 1 & 2 1L08-013 - 7 & 8
 1L08-011 - 3 & 4 1L08-014 - 9 & 10
 1L08-012 - 5 & 6 1L08-015 - 11 & 12



(Not all items are on this page, some are on the previous page)

The credit display is suspended from the top of the console. It is mounted on four downward facing screws (item 20.) The console is between the screw heads and spacers (item 22) and the credit display PCB is between the spacers & the thumb nuts (9.) The credit label (item 13) conceals the screw heads from above.

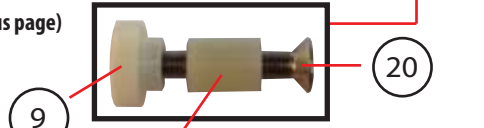

The installation fixing kit is supplied in the spares pack (Page 15)

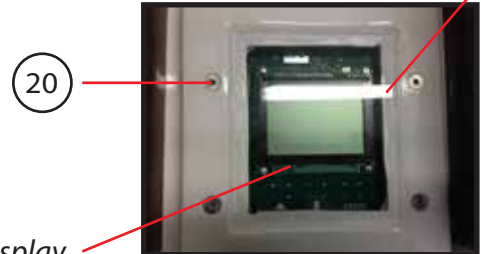

3J02-852 - Credit display

Note: The information contained in this publication is correct at the time of printing, but owing to the continued development of the products, changes in the specification may be inevitable. The manufacturer reserves the right to implement such changes without prior notice.



Item	Part Number	Description
1	2G00-210	Genesis boat steering wheel mould brown drilled
2	5J07-001	Forward/reverse stick assembly (see page 5 for breakdown)
3	3J02-600	Remotes optical forward/reverse PCB 2014
4	0H01-180	Steering wheel 270deg optical control assembly
5	2J00-105	Steering wheel red LED assembly
6	2J00-106	Steering wheel green LED assembly
7	2J00-107	Optical steering mechanism loom
8	1H01-210	Genesis boat steering wheel extension shaft
9	0F00-902	Washer M14A steel zinc plated
10	0F00-901	Nut M14 steel zinc plated
11	1H01-300	Spacer nylon 46x18x10mm (only used with 1H01-260)
12a	1H01-260	Boat steering wheel Fijian mahogany 95 (Pirate theme)
12b	1H01-239	Boat steering wheel metal (Mini marina theme)
13a	1H01-135	Pirate boat stick lever stainless steel (Pirate theme)
13b	1H01-148	Sport cruiser forward/reverse tick stainless steel (Mini marina theme)
14a	1L01-221	Pirate boat forward/reverse S/W decal coloured (Pirate theme)
14b	1L01-230	Genesis boat forward/reverse panel light walnut (Mini marina theme)
15	1L01-146	Forward/reverse stick label (only used with 1L01-230)
16a	1L01-222	Pirate boat dashboard S/W decal coloured (Pirate theme)
16b	1L01-232	Genesis boat dashboard panel light walnut (Mini marina theme)
17	1L01-155	Genesis instrument dash panel decal set (only used with 1L01-232)
18	0H00-252	Gear knob 90 (only used with 1H01-135)
19	0H00-255	S/A NIC neoprene sponge 15mm x 1/2"
20	0E00-369	Push button act. indicator green circular
21	0E00-423	Bulb 24v T3 1/4 10mm wedge
22	1L01-910	Tornado International bubble label 23x53mm (only used with 1L01-230)
23	0F00-606	Nut M6 nyloc stainless steel
24	0F00-609	Washer M6B stainless steel
25	0F00-654	Cap Screw M6x12mm stainless steel
26	0F00-664	M Screw M6x12mm socket button head stainless steel
27	0F05-016	Black pop rivet aluminium domed open 3.2x11.5mm
28	0F00-568	M Screw M5x20mm security socket button head stainless steel (only used with 1H01-239)
29	0F05-156	Pop rivet aluminium domed bulbex 4x21.3mm
30	0F07-353	Cable 'P' clip 12.5mm white
31	1H02-151	Genesis boat slot shield right hand
32	1H02-152	Genesis boat slot shield left hand
33	0F00-655	Cap screw M6x16mm stainless steel (only used with 1H01-239)
34	1L01-220	Genesis pirate boat sword panel coloured (Pirate theme)
35	0H01-182	Optical PCB gear set & bracket (part of 0H01-180, can be bought separately)
36	0H01-184	Optical switch gear 60T 15mm bore (part of 0H01-180, can be bought separately)
37	1H00-252	Metal boat steering wheel centre cap (part of 1H01-239, can be bought separately)

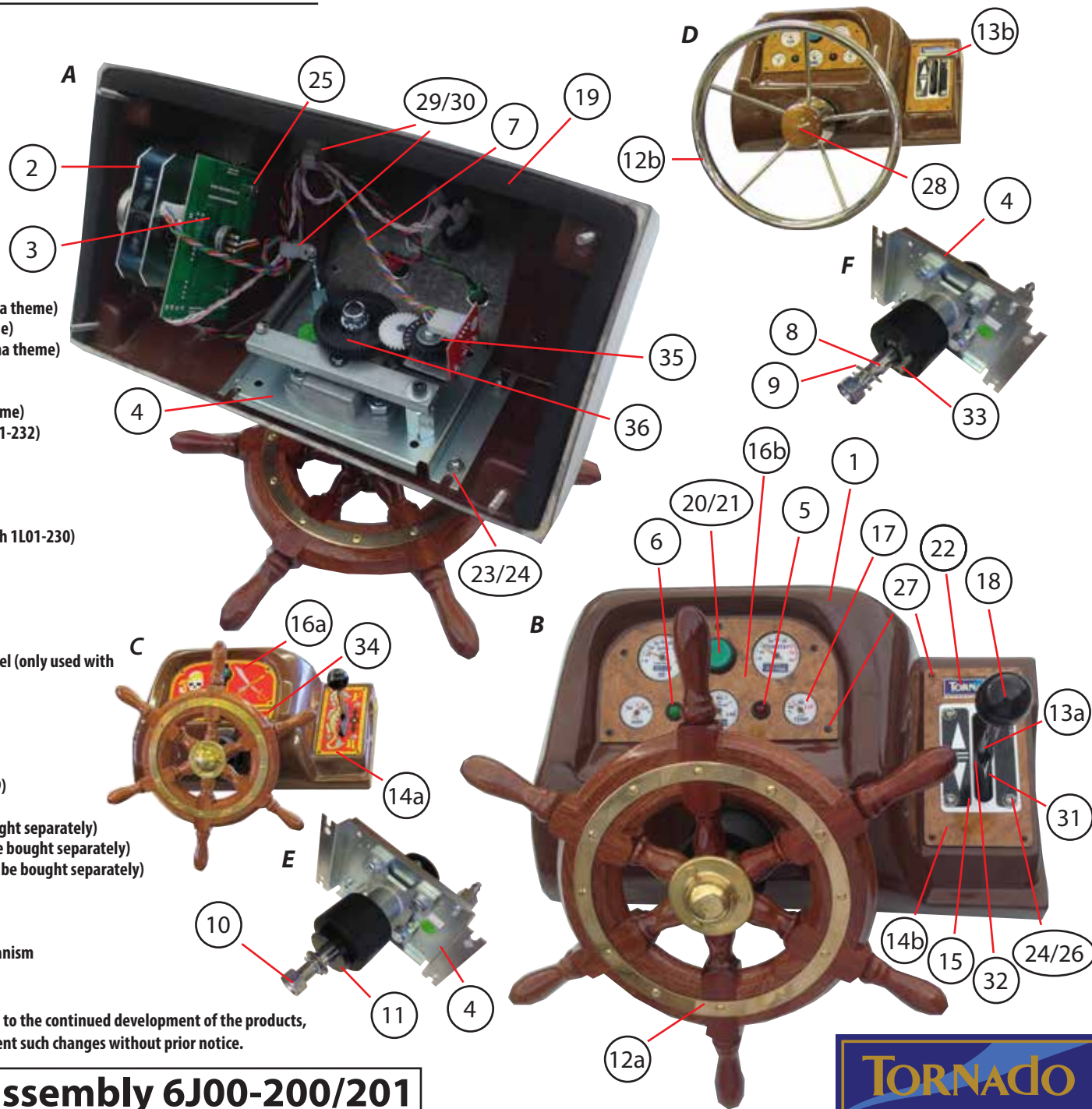

A - Underside view
 B - Front view
 C - 6J00-201 - Pirate theme

D - 6J00-200 - Mini marina theme
 E - Pirate steering wheel mechanism
 F - Mini marina steering wheel mechanism

Themes can be mixed upon request (as shown in picture B)

Note: The information contained in this publication is correct at the time of printing, but owing to the continued development of the products, changes in the specification may be inevitable. The manufacturer reserves the right to implement such changes without prior notice.

-4- Genesis boat steering wheel assembly 6J00-200/201



Item	Part Number	Description
1	2H00-209	DL forward/reverse stick bearing slot
2	1H00-246	DL plate spacer
3	1H00-248	DL stick arm collar
4	1H01-136	End stop
5	1H00-518	Forward/reverse collar 30mm with pin
6	1H01-139	Stick side plate spacer
7	1H01-142	Stick mounting plate
8	1H01-143	Stick side mounting plate
9	1H01-144	Stick side plate
10	1H01-145	Forward/reverse stick boss
11	0H01-190	F/F hex spacer - zinc plated 10x35mm M6 thread
12	0H00-220	Switch disc spring
13	0F00-541	Socket set screw M5x5mm KCP stainless steel
14	0F00-606	Nut M6 nyloc stainless steel
15	0F00-640	M screw M6x60mm slot pan head stainless steel
16	0F00-709	M screw M6x60mm hex head stainless steel
17	0F00-959	Washer M20 form B stainless steel

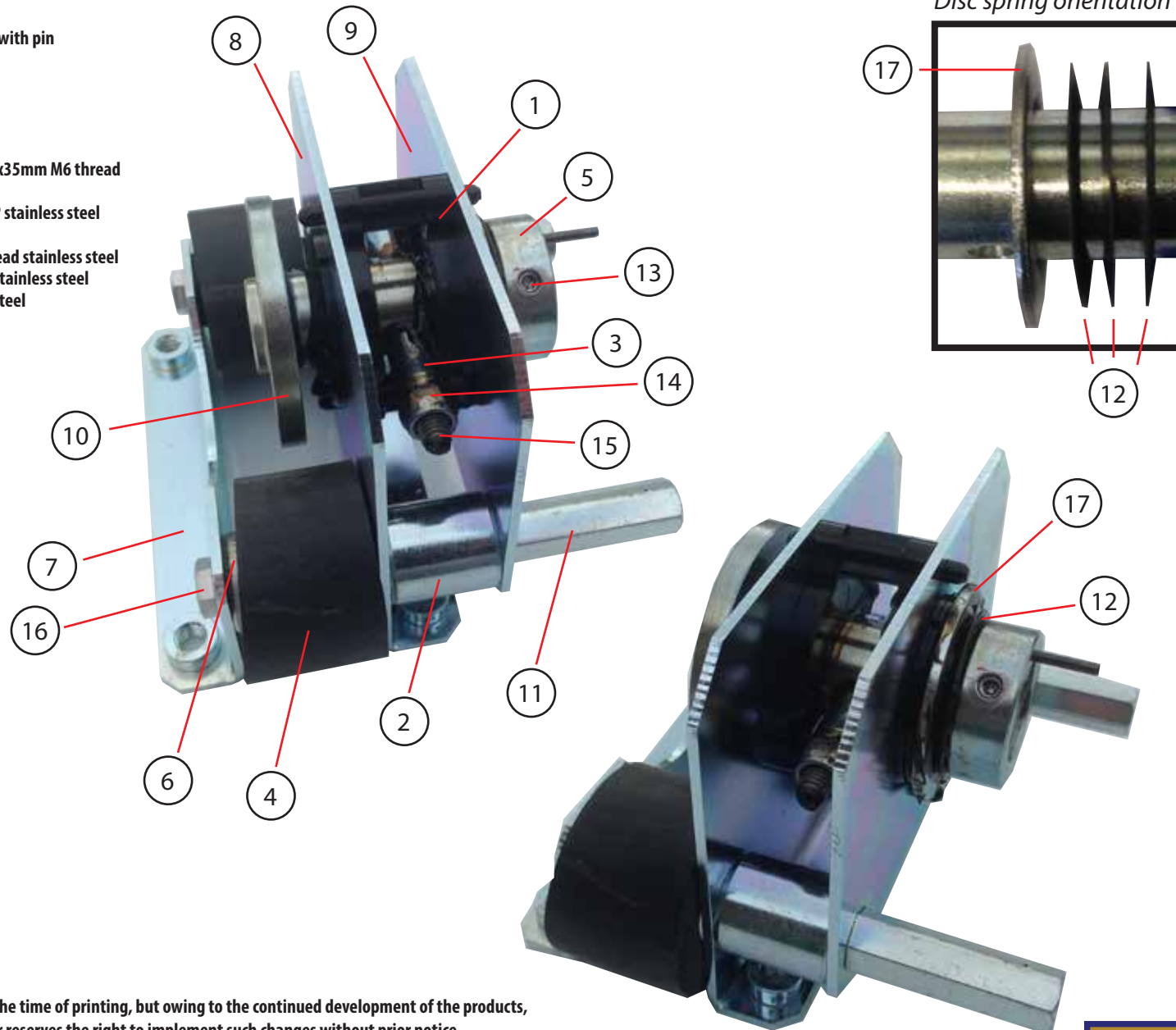

Note: The information contained in this publication is correct at the time of printing, but owing to the continued development of the products, changes in the specification may be inevitable. The manufacturer reserves the right to implement such changes without prior notice.

-5- Genesis boat forward/reverse stick assembly 5J07-001



Item	Part Number	Description
1	0H00-008	Lock & tongue assembly C/W key 281901
2	0F05-506	Nut M5 thumb nylon knurled
3	1H01-250	Coin door PCB bracket
4	0H00-016	Cranked cam 65296-5000 (Dimension B-30mm) ¹
5	0A00-758	Stainless steel double entry coin door with hinge ²
6	0A00-759	Black frame for standard door 62-0012
7	0A01-758	Faceplate & microswitch 12v 62-0013
8	0A01-759	Clamps door 62-0014
9	0A01-760	M5 H8x10 hex washer 62-0015
10	0F07-283	Clamp for 16 way ribbon cable
11	0F07-284	Clamp for 16 way ribbon cable with sticky back

3J02-853 - Genesis 2007 multi mech connection PCB (sold separately)

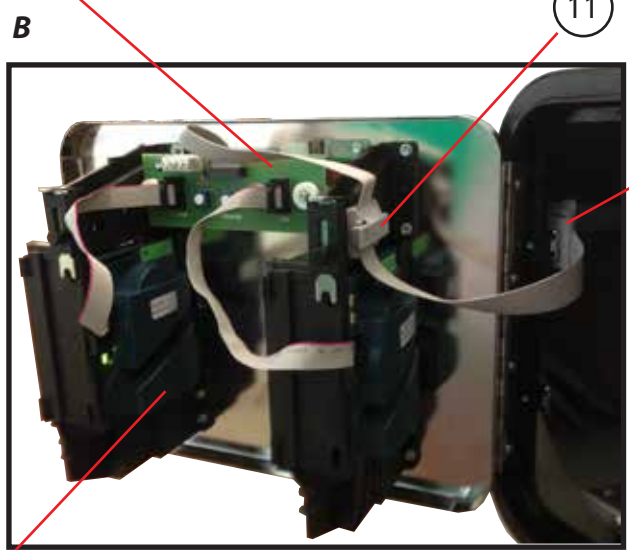

0A01-008 - QL microcoin multi coin acceptor (sold separately)



A - Inside view of frame
 B - Inside view of door, including QL coin acceptors and multi mech connection PCB
 C - Top view

¹Other cranked cams are available for older door frames

²Blank doors and doors cut for note acceptors can also be specified.

Note: The information contained in this publication is correct at the time of printing, but owing to the continued development of the products, changes in the specification may be inevitable. The manufacturer reserves the right to implement such changes without prior notice.

-6- Multi mech coin door - 3J01-850



Item	Part Number	Description
1	7J01-851	DS transmitter 137KHz C/W Cover 91 (boat)*
	7J01-852	DS transmitter 100KHz C/W Cover 90 (truck)*
	7J01-854	DS transmitter 120KHz C/W Cover 93 (car)*
2	7J00-893	DS master timer 24v
3	4J01-857	Genesis TX motherboard & carrier assembly
4	4J01-850	DS 16m TX carrier cover
5	4J01-854	DS loop transformer 132/137KHz*
6	2J01-851	TX channel shorting plug assembly
7	1V00-855	DS TX cover 137KHz black (boat)*
	1V00-856	DSTX cover 100KHz white (truck)*
	1V00-158	DS TX cover 120KHz blue (car)*
8	0F00-311	M Screw M3x6 pan head pozi stainless steel
9	0F00-308	Washer M3A stainless steel
10	0F00-370	Nut M3 stainless steel
11	1L00-053	Genesis TX motherboard label & timer label

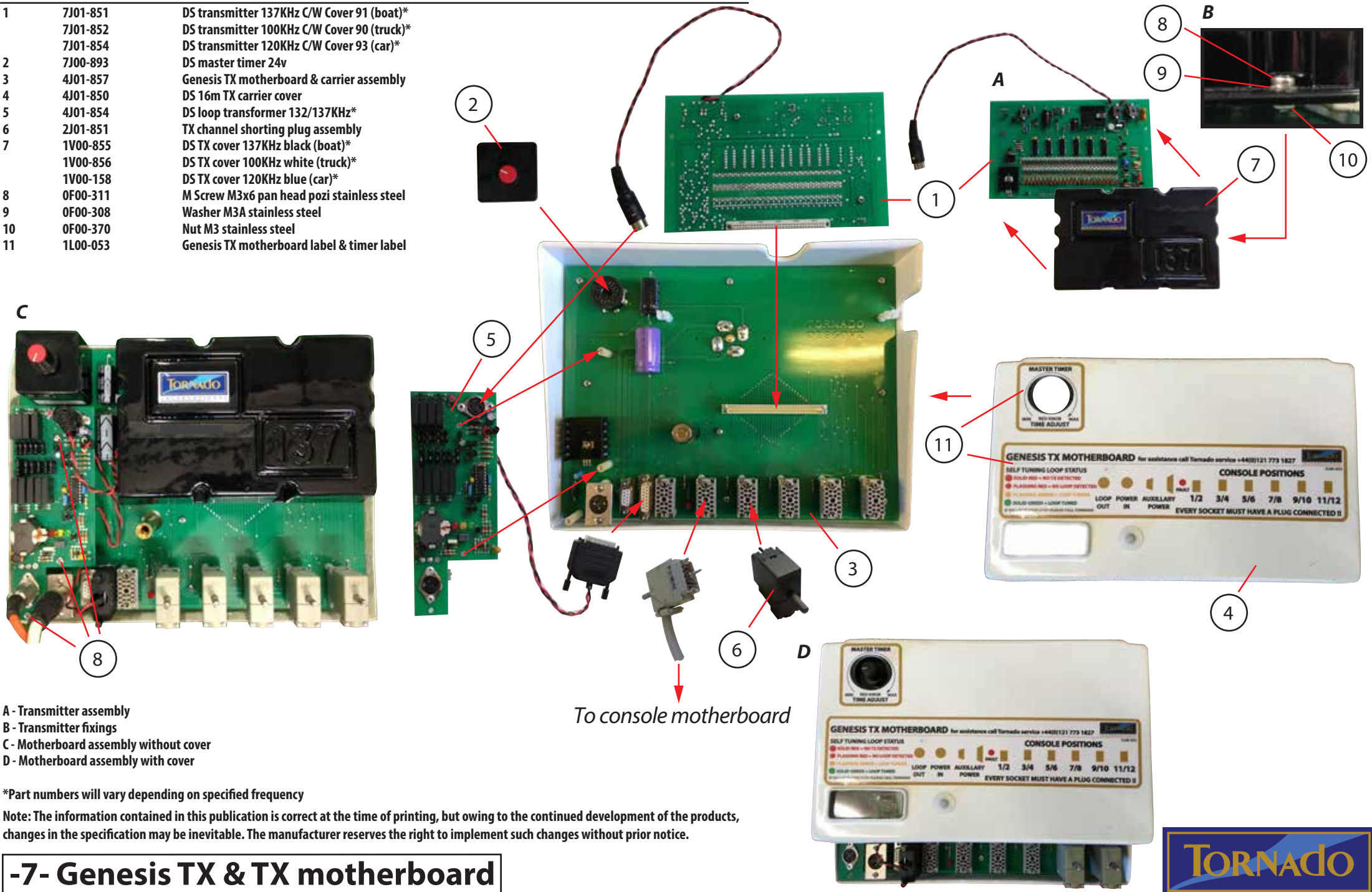

A - Transmitter assembly
 B - Transmitter fixings
 C - Motherboard assembly without cover
 D - Motherboard assembly with cover

*Part numbers will vary depending on specified frequency

Note: The information contained in this publication is correct at the time of printing, but owing to the continued development of the products, changes in the specification may be inevitable. The manufacturer reserves the right to implement such changes without prior notice.

-7- Genesis TX & TX motherboard



Item	Part Number	Description
1	6J00-885	Console mother PCB assembly 99
2	2J08-006	"End of go" warning board assembly
3	3J02-852	Genesis credit display PCB 2007
4	7J00-890	Genesis 2004 dual slave timer 24v
5	3J00-857	Genesis credit display interface

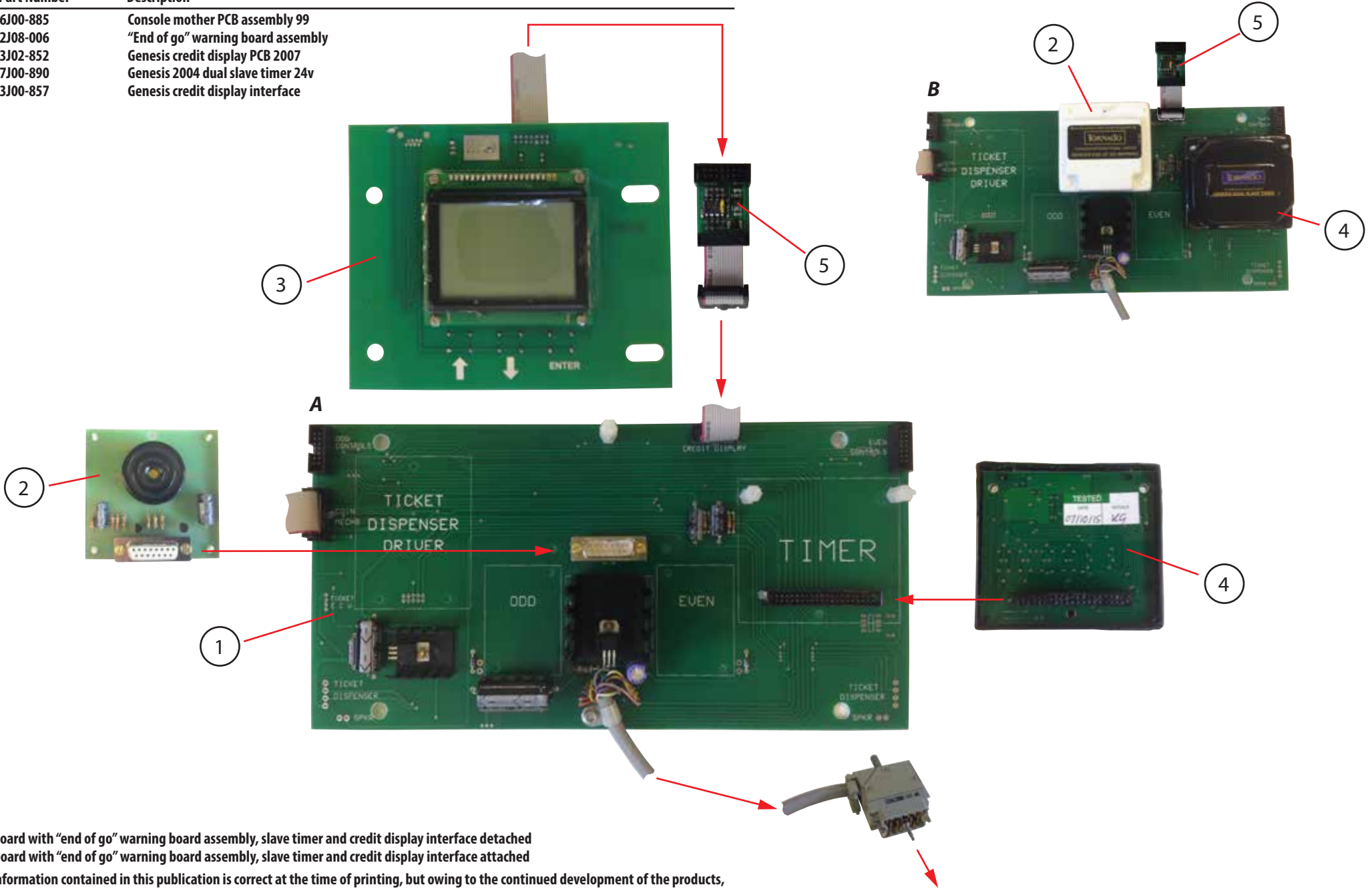

A - Motherboard with "end of go" warning board assembly, slave timer and credit display interface detached
 B - Motherboard with "end of go" warning board assembly, slave timer and credit display interface attached

Note: The information contained in this publication is correct at the time of printing, but owing to the continued development of the products, changes in the specification may be inevitable. The manufacturer reserves the right to implement such changes without prior notice.

-8- Genesis boat console motherboard

To TX motherboard



Item	Part Number	Description
1	4J00-940	2009 Universal PSU assembly cased - Available in 100v - 240v
2	0E00-157	Fuse 20mm 5A quick blow ceramic
3	0E00-158	Fuse 20mm 5A anti surge (T) HBC ceramic

Genesis power supply - 4J01-940

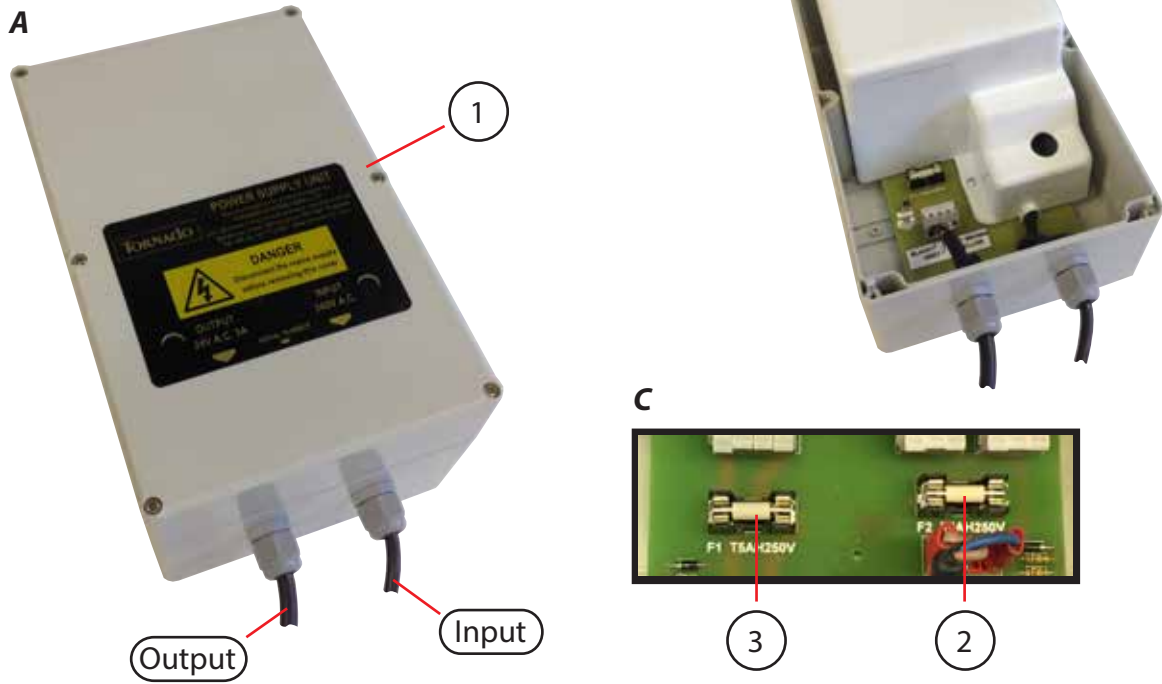

- OK00-270 - Type G IEC lead
- OK00-271 - Type B IEC lead
- OK00-272 - Type F IEC lead
- OK00-269 - Type I IEC lead

A - Power supply with lid
 B - Power supply without lid, with transformer housing
 C - Power supply PCB with both fuses exposed
 D - Output plug - 3 Pin XLR
 E - Mains input plugs - Can be specified to your local standard

Note: The information contained in this publication is correct at the time of printing, but owing to the continued development of the products, changes in the specification may be inevitable. The manufacturer reserves the right to implement such changes without prior notice.

**-9- Genesis power supply 4J01-940,
 Boat receiver 6J01-902**

6J01-902 - Genesis series boat receiver
 Part number will vary depending on specified frequency

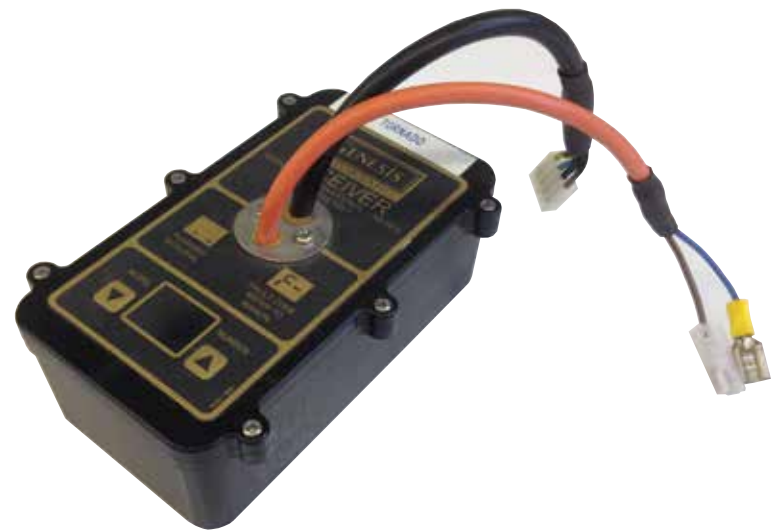

Fault codes for genesis boat receivers:

- F1 - Left hand motor overload
- F2 - Right hand motor overload
- F3 - Left hand motor short circuit
- F4 - Right hand motor short circuit



Item	Part Number	Description
1	7J00-962	Charger case S/A 6m boat 2009
2	4J01-960	2006 new charger module no leads 230V
	4J01-961	2006 new charger module no leads 115V (Pictured)
3	1W00-021	2006 charger bus bar interface lead
4	1W00-022	2006 charger battery lead boats
5	0F05-857	Self tap 4x 3/8" Pozi AB pan head stainless steel
6	2B00-002	Boat battery (complete with studs)
7	0E00-130	Fuse 2A quick blow glass

5J01-960 - Boat charger UK spec (230v)
 5J01-961 - Boat charger USA spec (115v)
 5J01-962 - Boat charger Europe spec (230v)
 5J01-963 - Boat charger other country spec

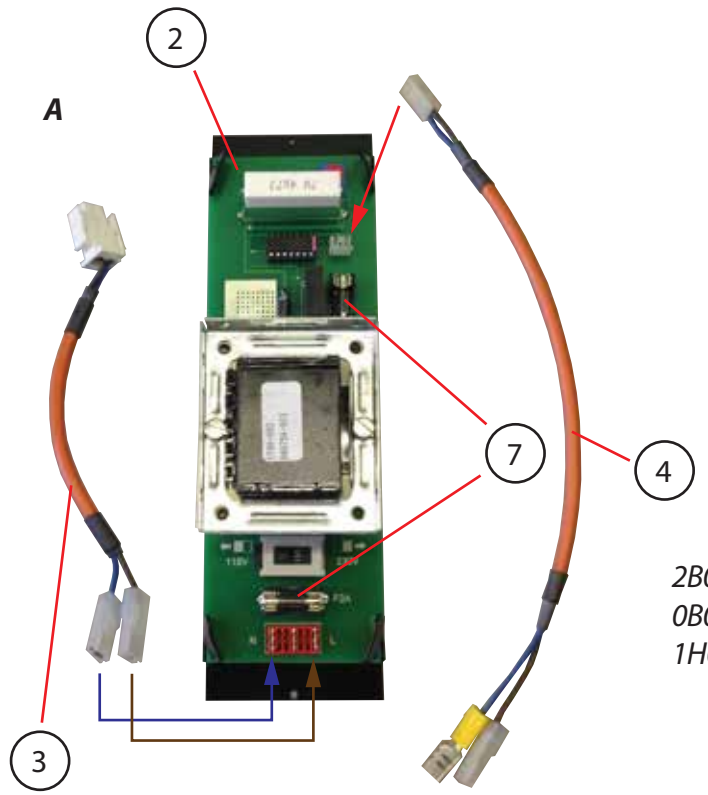

2B00-002 - Boat battery consists of;
 0B00-008 - Sonnenschein A512/6.5 S battery
 1H00-031 - Boat battery studs

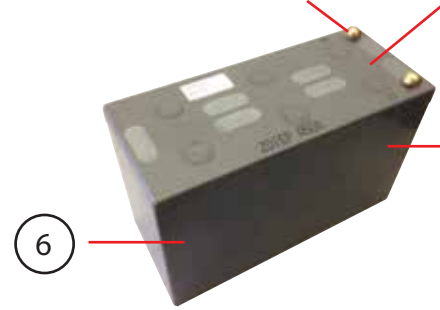

OK00-270 - Type G IEC lead
 OK00-271 - Type B IEC lead
 OK00-272 - Type F IEC lead
 OK00-269 - Type I IEC lead



A - Charger module lead attachment points
 B - Bus bar - located inside charger case
 C - Mains input plugs - Can be specified to your local standard where possible

Note: The information contained in this publication is correct at the time of printing, but owing to the continued development of the products, changes in the specification may be inevitable. The manufacturer reserves the right to implement such changes without prior notice.

-10- Genesis boat charger & battery



Item	Part Number	Description
1a	2G00-112	Hull high front any colour moulding drilled
1b	2G00-111	Hull low front any colour moulding drilled
2	2H00-956	Bumper strip boat 2m
3	2H00-957	Front bumper boat .275m
4	2J07-140	Battery & RX contact board
5	1H00-111	Top fixing peg (2mm stainless steel) ¹
6	1H00-135	Battery contact strip large M. stainless steel
7	1H00-136	Battery contact strip small M. stainless steel
8	1V07-005	Supercruiser battery terminal cover
9	0F05-015	Pop rivet aluminium domed open 3.2x11.5mm
10	0F05-161	Pop rivet aluminium domed bulbex 4.8x23.3mm
11	0F05-507	Split pin 3/32"x3/4"
12	0F05-857	Self tap 4x3/8" pozi AB pan head stainless steel
13	1H01-209	80cm boat RX retaining bracket
14	0F00-305	Nut M3 nyloc stainless steel
15	0F00-308	Washer M3A stainless steel
16	0F00-337	M screw M3x30mm pan head stainless steel
17	0E00-979	Grommet PVC 43mm
18	1L01-910	Tornado Int. bubble label 23x53mm
19	1V01-600	80cm boat catch plate ¹
20	1H00-109	Motor sleeve black
21	1H00-113	Propshaft & coupling assembly
22	0H00-019	Propellor 50mm SR M4 red nylon
23	0F00-342	Grub screw stainless steel M3x5mm PCP
24	0F00-401	Nut M4 brass
25	0F00-408	Washer M4 brass
26	0H00-739	Spacer nylon 4.2x8x4mm
27	0H00-991	Boat dust cap 1 3/4"
28	1H01-910	River boat RX catch spacer ²
29	1H01-911	River boat rear fixing peg ²
30	1H01-060	Boat catch threaded plate M8 ²
31	0F00-336	M screw M3 x 35mm pan head stainless steel ²

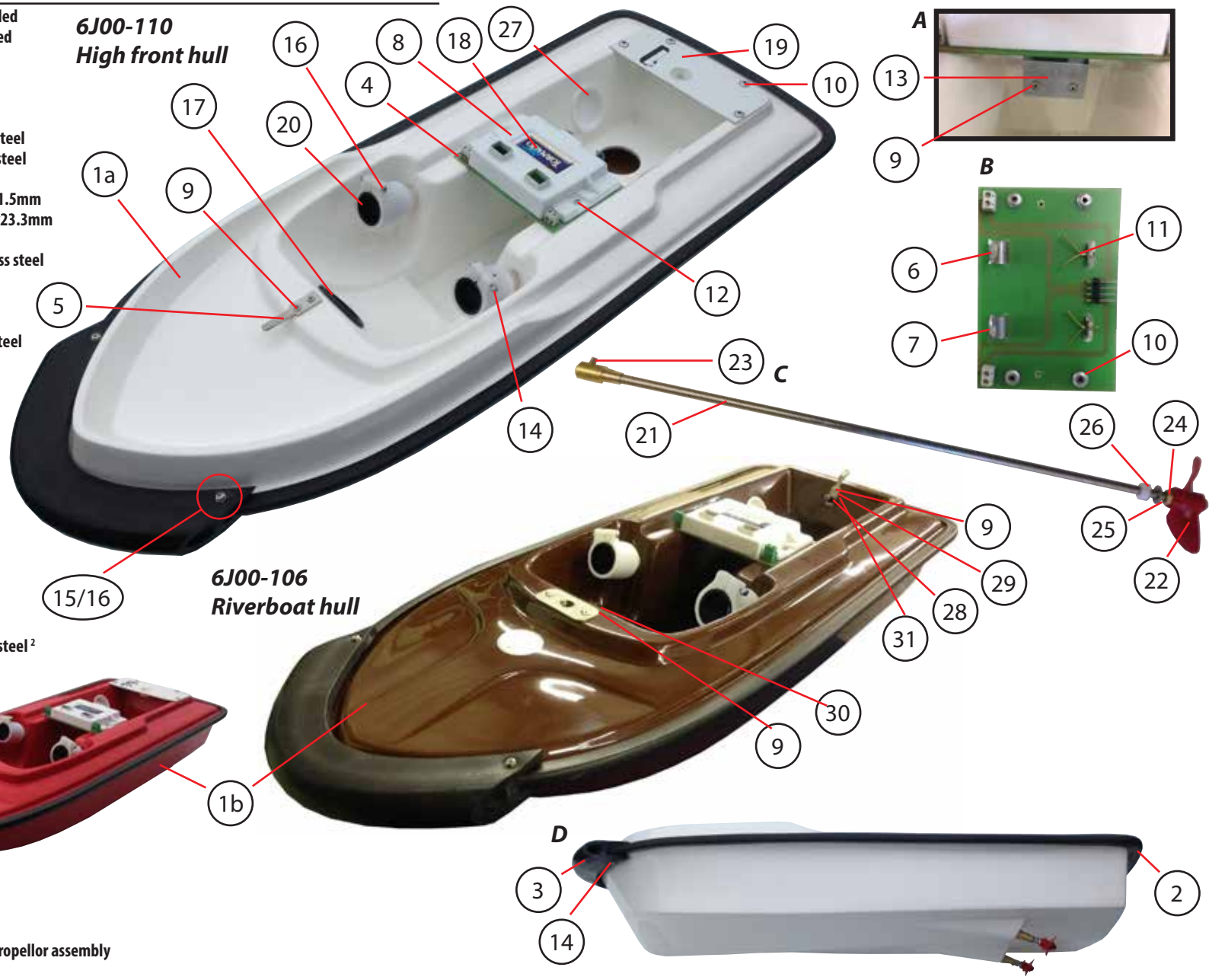

¹ For 6J00-110 high front full & 6J00-109 low front hull only
² For 6J00-106 riverboat hull only

A - View from beneath battery & RX contact board
 B - Underside of battery & RX contact board
 C - Propshaft & propellor assembly
 D - Side view

Note: The information contained in this publication is correct at the time of printing, but owing to the continued development of the products, changes in the specification may be inevitable. The manufacturer reserves the right to implement such changes without prior notice.

Item 2 is secured to the hull underneath Item 3 by two screws (Item 12)

-11- Genesis 80cm boat hull less motors 6J00-106/109/110

Any colour from our standard range can be specified. Low front hulls can be converted to riverboat hulls.



7J00-106 - Genesis complete 80cm river boat hull low front



0M00-003 - Motor clear seal (Can be purchased separately)

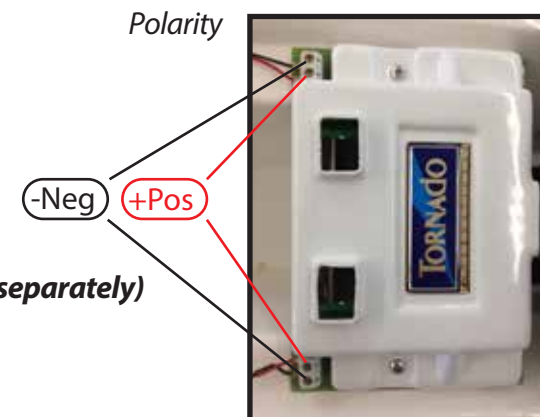

7J00-108 - Genesis complete 80cm boat hull low front



7J00-109 - Genesis complete 80cm boat hull high front



Note: The information contained in this publication is correct at the time of printing, but owing to the continued development of the products, changes in the specification may be inevitable. The manufacturer reserves the right to implement such changes without prior notice.

-12-Genesis boat hull complete 7J00-106/108/109



Tops with standard catch system

Thumbscrew



Locating hole

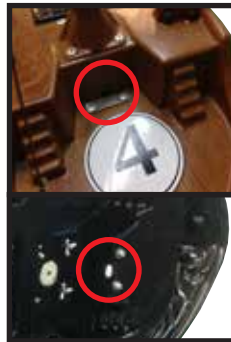

Thumbscrew hole

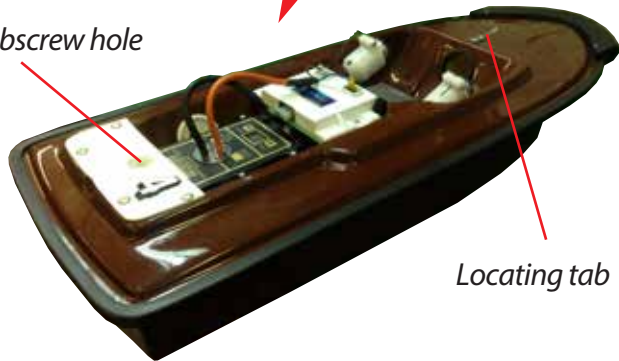

Locating tab

All 80cm boat tops with the exception of Riverboat tops use the standard catch system, as shown above.

Slide the locating hole over the locating tab, then fasten the thumbscrew into the thumbscrew hole to secure.

When using the 'Dhow' top (3J00-171,) fasten the Dhow Adaptor into the thumbscrew hole before affixing the top.

Dhow Adaptor



Riverboat Top

Thumbscrew



Locating slot

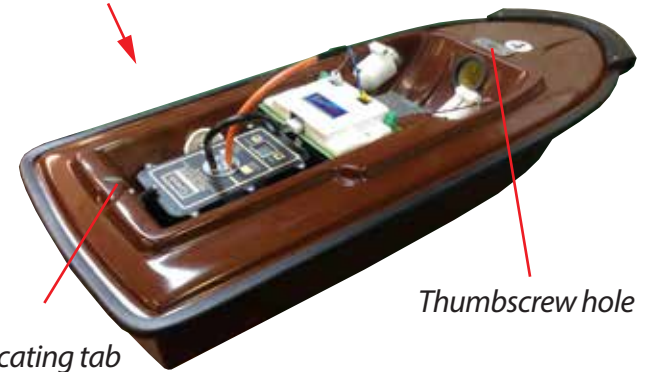
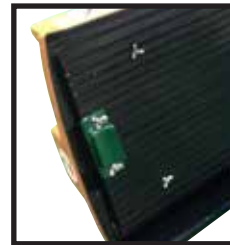

Locating tab

Thumbscrew hole

Slide the locating slot over the locating tab, then fasten the thumbscrew into the thumbscrew hole to secure.

Note: The information contained in this publication is correct at the time of printing, but owing to the continued development of the products, changes in the specification may be inevitable. The manufacturer reserves the right to implement such changes without prior notice.

1a	3J00-151	Fire boat
1b	3J00-151	Police boat
2	3J00-152	Cruiser
3	3J00-153	Speed boat ¹
4	3J00-154	Ocean liner ¹
5	3J00-156	Trawler
6	3J00-104	Tug
7	3J00-162	Pirate ship (Standard PVC) ¹
8	3J00-155	Paddle boat ¹
9	3J00-165	Gator
10	3J00-166	Jumbo
11	3J00-167	Chimp
12	3J00-168	Bear
13	3J00-169	Rhino
14	3J00-170	Lion
15	3J00-157	Shark fisherman
16	3J00-158	Steam tug
17	3J00-159	Steam launch
18	3J00-164	Pirate ship (Woodgrain) ¹
19	3J00-171	Dhow ¹
20	3J00-176	River boat (River princess) ²
21	3J00-177	River boat (Water gypsy) ²
22	3J00-178	River boat (Firefly) ²
23	3J00-179	River boat (African queen) ²

¹ Compatible with low front hulls only

² Compatible with river boat hulls only



Note: The information contained in this publication is correct at the time of printing, but owing to the continued development of the products, changes in the specification may be inevitable. The manufacturer reserves the right to implement such changes without prior notice.

-14- Genesis 80cm boat tops



Item	Part Number	Description
1	0H00-600	Spares box trunk
2	1V00-050	Spares pack tray insert
3	0M00-003	Motor clear seal
4	0E00-423	Bulb 24v T3 1/4 10mm wedge
5	0H00-003	Metric small spanner set
6	0H00-004	Tommy bar
7	2H00-901	Set of allen keys (boat)
8	2J00-200	3 pin DIN plug loop lead
9	3J02-600	Remotes optical forward/reverse PCB 2014
10	2E00-871	Pack of fuses
11	0H00-019	Propeller 50mm SR M4 red nylon
12	1H00-113	Propshaft & coupling assembly
13	0W00-080	Cable 24/.2mm SGL black (loop wire)
14	2F00-903	Pack of screws & nuts (boat)
15	2J00-020	Tornado leather keyfob & keys
16	2J01-851	TX channel shorting plug assembly
17	0N01-316	3 in 1 oil 100ml flexican
18	0N01-317	Pure petroleum jelly 100g (Vaseline)
19	1F00-001	Charger & PSU xings
20	7J01-851	DS transmitter 137 kHz*
21	7J00-890	Dual slave timer
22	7J00-893	Master timer
23	6J01-902	Genesis boat receiver*
24	1N00-510	Genesis boat user/installation manual & poster
25	2J07-108	80cm boat stand
26	2J00-805	Installation xing kit

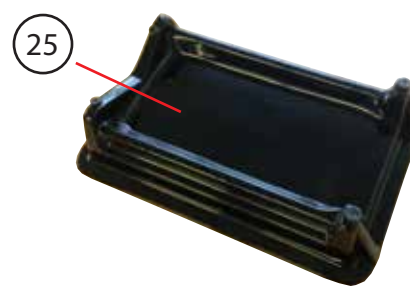
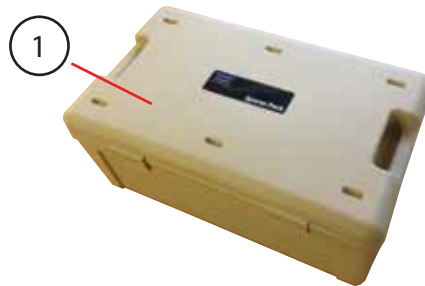
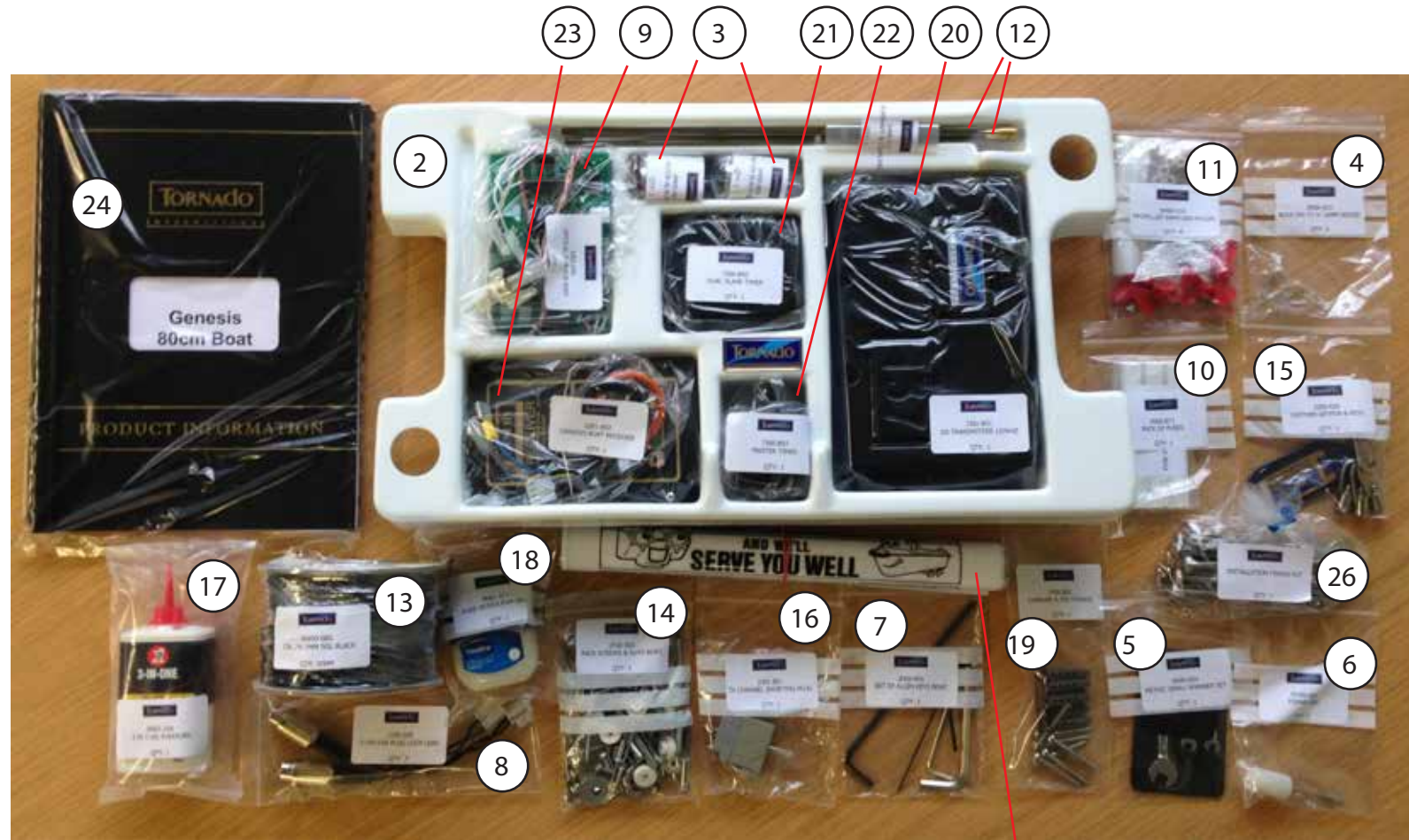

24

*Part numbers will vary depending on specified frequency

Note: The information contained in this publication is correct at the time of printing, but owing to the continued development of the products, changes in the specification may be inevitable. The manufacturer reserves the right to implement such changes without prior notice.

-15- Genesis 80cm boat spares pack

